

ISOLATED APPLICATION

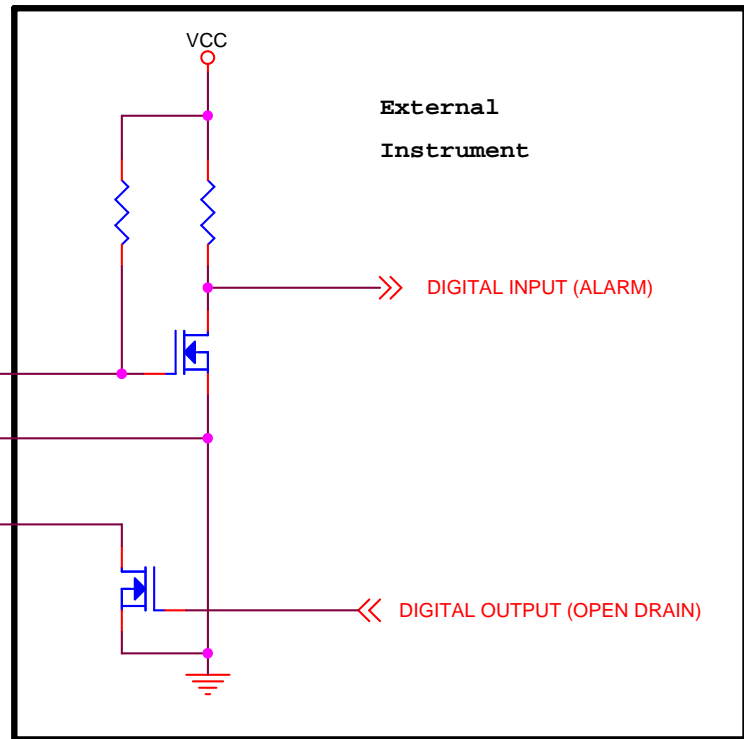

NON-ISOLATED APPLICATION

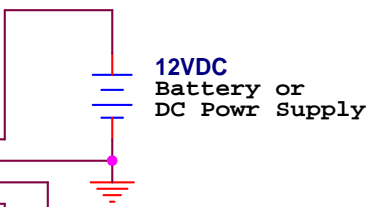
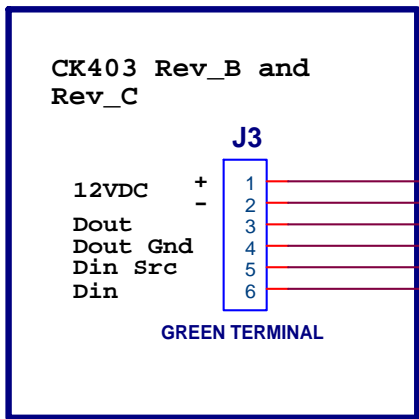
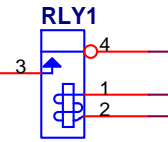
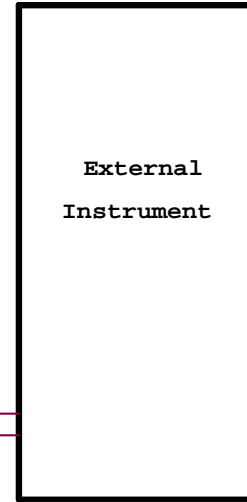
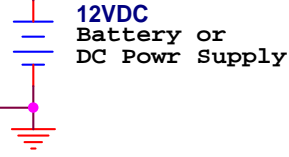
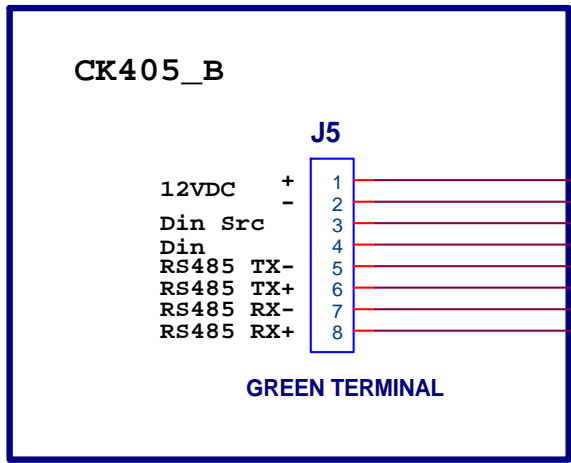

12 V / 250 mA (Max.)

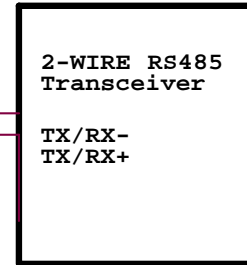
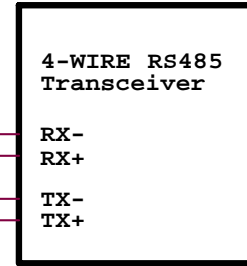
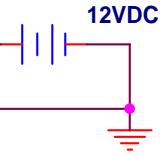
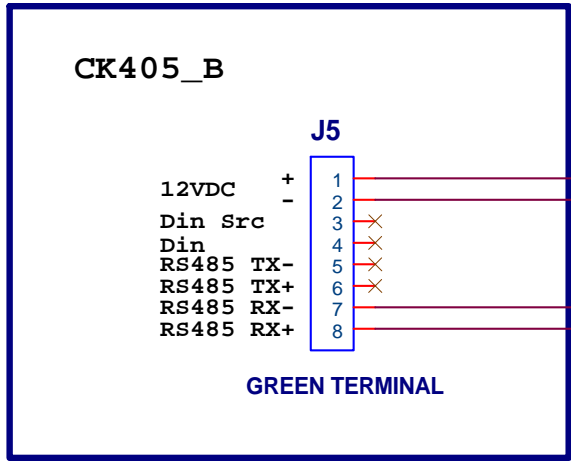

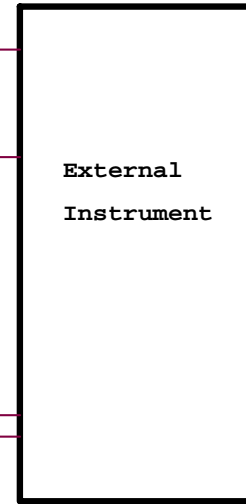
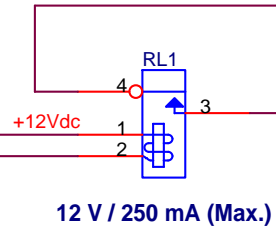
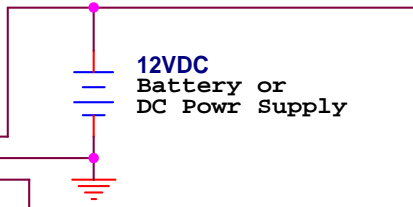
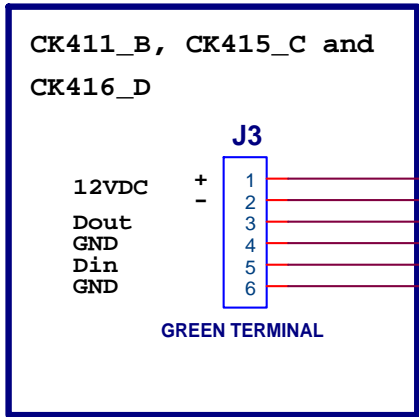

ISOLATED APPLICATION

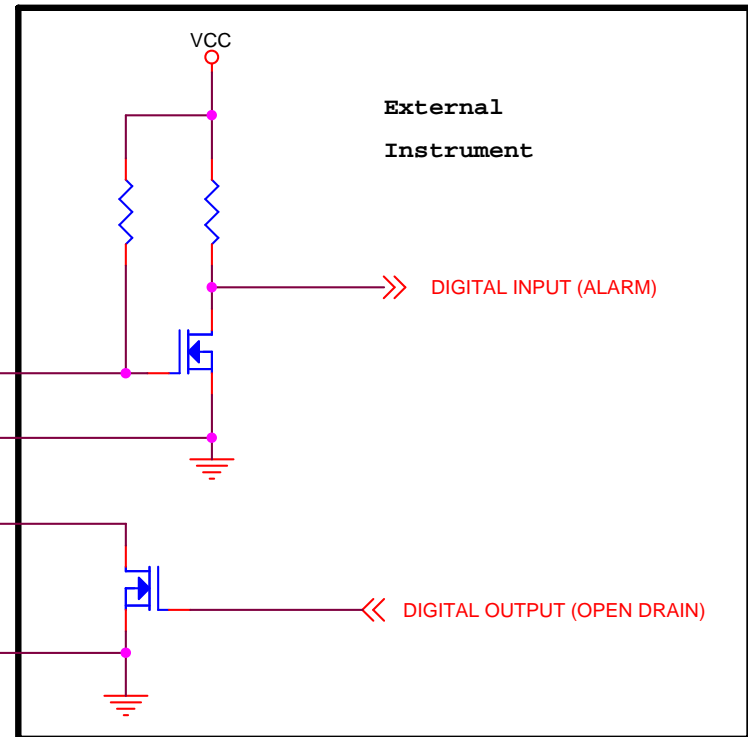
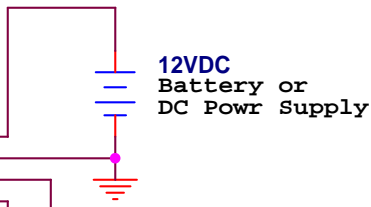
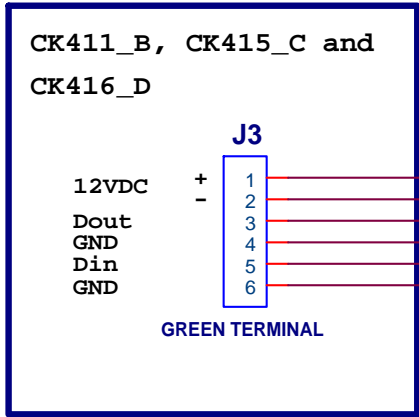
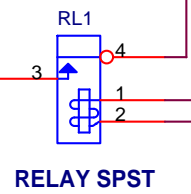

NON-ISOLATED APPLICATION

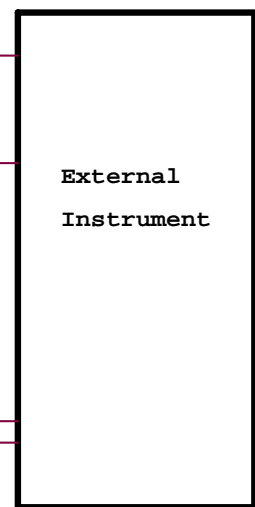
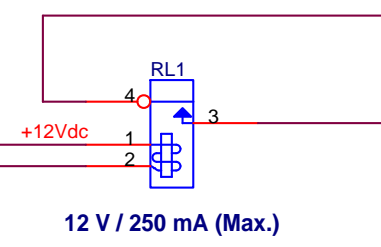
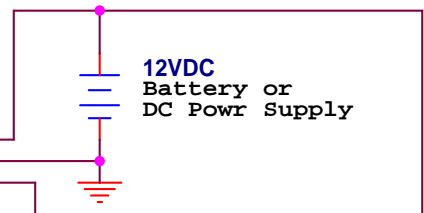
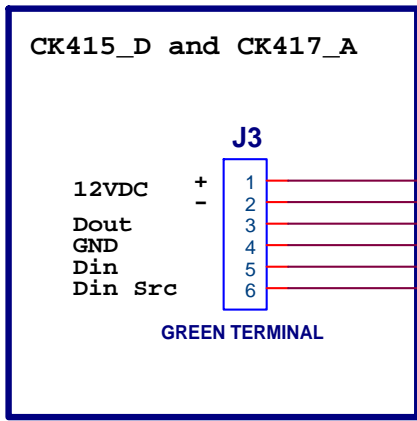

ISOLATED APPLICATION

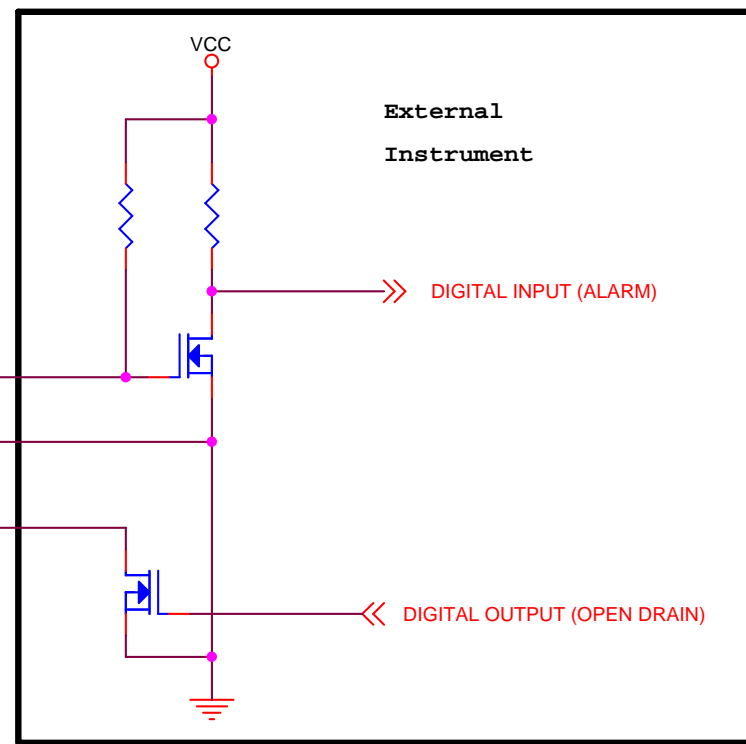
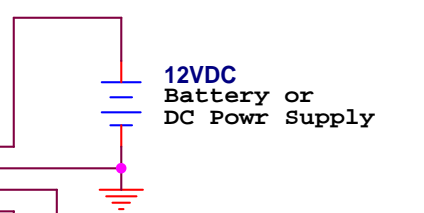
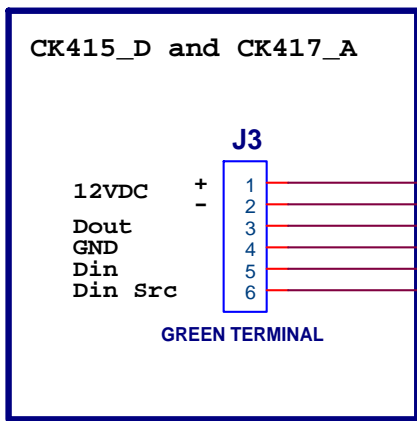
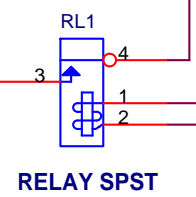

NON-ISOLATED APPLICATION

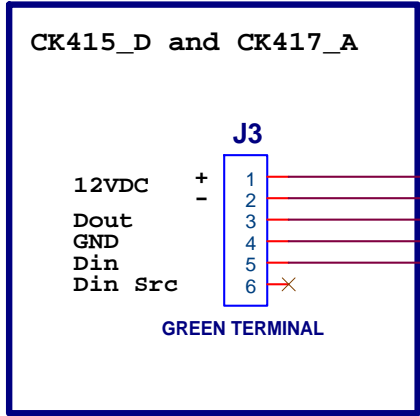

12VDC
Battery or
DC Power Supply

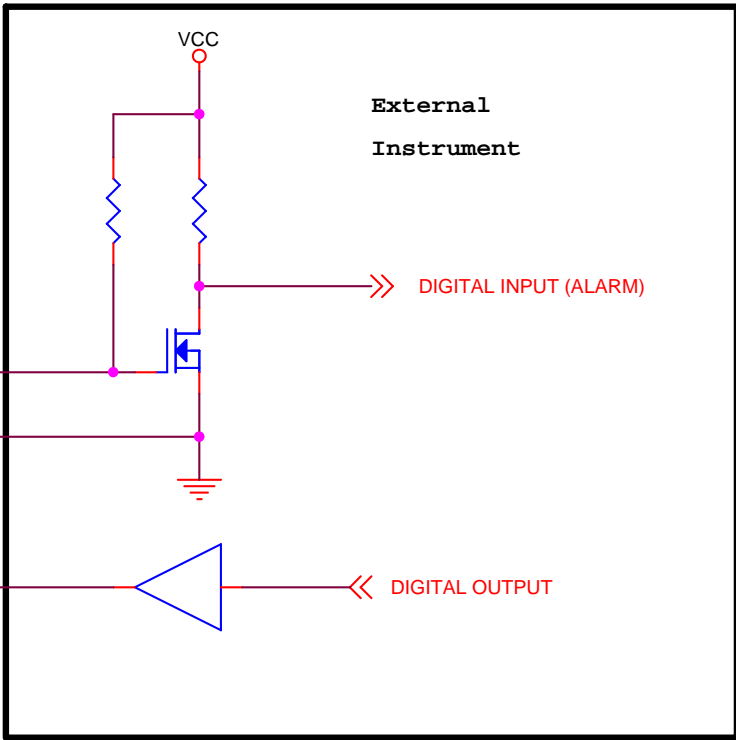

+3.3 to 24 Vdc

NON-ISOLATED APPLICATION