

**CTEK**  
*Series 4200*  
*SkyRouter*  
**CDMA 1xEV-DO Router**

# **USER MANUAL**

## **Series 4200E**

Part Number 91-601-01  
Firmware Release 1.00



**Ctek - Innovating Wireless Value**

# Table of Contents

<b>TABLE OF CONTENTS</b>	<b>I</b>
<b>PREFACE</b>	<b>1</b>
<b>1 INTRODUCTION</b>	<b>1</b>
1.1 Theory Of Operation	1
1.2 Features	1
<b>2 CONNECTORS, LIGHTS, SWITCHES, AND JUMPERS</b>	<b>3</b>
2.1 Switches	3
2.2 Lights	3
2.3 Connectors	5
<b>3 START UP</b>	<b>6</b>
3.1 Power	6
3.2 Connecting The Antenna	6
3.3 Connecting to the Ethernet Port – Administrative Connection	6
<b>4 ADMINISTRATION, CONFIGURATION AND STATUS</b>	<b>8</b>
4.1 Getting Started	8
<b>4.2 Interfaces</b>	<b>9</b>
4.2.1 Configuring The Wireless Interface	9
4.2.2 Configuring The Ethernet Interace	12
4.2.3 Configuring The Relay Input Interface	14
4.2.4 Configuring The Relay Output (Driver) Interface	15
<b>4.3 Services</b>	<b>16</b>
4.3.1 Password Administration	16
4.3.2 Routing and Forwarding Services	17
4.3.3 Admin Screen Services	19
4.3.4 Wireless Activation Services	<b>Error! Bookmark not defined.</b>
4.3.5 Applications	25
<b>4.4 Status</b>	<b>25</b>
4.4.1 Wireless Status	25
4.4.2 Ethernet Status	28

<b>5</b>	<b>SPECIFICATIONS</b>	<b>29</b>
<b>6</b>	<b>CERTIFICATIONS</b>	<b>30</b>
<b>7</b>	<b>APPENDIX A</b>	<b>31</b>

## Preface

Welcome to the Ctek Series 4200E SkyRouter User's Guide. The User's Guide will explain the basic operation of a SkyRouter and take you through the necessary settings to get your wireless application online. Additional information and applicable technical notices can be found at [www.ctekproducts.com](http://www.ctekproducts.com).

## 1 Introduction

SkyRouter provides application and network designers with a bridge between the world of IT infrastructure and the evolving wireless data networks. With SkyRouter the wireless transport is fully integrated into the product's routing fabric meaning that you can approach the setup and operation of this product much as with any other IP addressable device. Wireless considerations are reduced to the absolute minimum necessary to register and make connections on a network.

### 1.1 Theory Of Operation

The Series 4200E SkyRouter is a complete IP router that routes traffic over LAN Ethernet (10/100baseT) connections. The wireless features of SkyRouter simply extend the IP routing capabilities to include routing and network address translation (NAT) over CDMA EV-DO wireless networks. A fallback 1xRTT transport is also provided. As with most routers Ctek's Series 4200E SkyRouter can be viewed as having a Local Area Network (LAN) side and a Wide Area Network (WAN) side. Traffic originating at SkyRouter's Ethernet ports is considered LAN traffic. The Wide Area Network connection is over the wireless network's 1XRTT transport.

### 1.2 Features

This manual covers SkyRouter (4200E) Release 1.00 and contains the following feature and functions.

- 1) Ethernet
  - a. Static Addressing
  - b. Dynamic (DHCP) Server
  - c. DHCP Client
  - d. Configurable DNS address
  - e. Configurable Gateway, Sub net mask, and Broadcast address
  - f. Port Forwarding
  - g. Service management
- 2) CDMA Interface
  - a. Enable/Disable Wireless Routing
  - b. Enable/Disable inbound IP requests
  - c. Name Server Interoperability with UDP or SMS
  - d. DDNS Interoperability with BIND or MS Server
  - e. Administration web server port address selection
  - f. Enhanced IOTA, OTA and manual activation
  - g. Home Network Selection
- 3) Relay Contact Closure (detection and operation)
  - a. NO/NC detection
  - b. SMS or email cry out alarm

**Part Number 91-601-01**  
**Release 1.00**

- 4) Relay Driver Output
  - a. SMS Activation
  - b. Web Activation
  
- 5) General Administration
  - a. Modify Password
  
- 6) Status – Ethernet Status
  - a. Currently Assigned IP Address
  - b. Current MAC Address
  
- 7) Status – CDMA Status
  - a. ESN (Serial Number) Hex and Decimal
  - b. Network Assigned IP Address
  - c. Telephone Number (MIN)
  - d. Current Network Status Active/Inactive
  - e. Signal Level (RSSI)

## 2 Connectors, Lights, Switches, and Jumpers

### 2.1 Switches

Referring to Figure 1, there are two switches on the front of the Series 4200E. S1 (Reset) causes a hard reset of unit. S2 (DFLT) is used to completely restore the firmware settings that were included when the product was shipped from the factory. To restore factory defaults, the unit must be running. Press the Restore Defaults (inner) switch and hold it down for 10 seconds. After 10 seconds, you will see both the green and yellow lights go off. At that time you may either press the reset (outer) switch or cycle power on the unit.



Figure 1

### 2.2 Lights

The Series 4200E SkyRouter has indicators as shown in Figure 1.

**LAN1 – LAN4** – The LAN indicators indicate that an Ethernet port is connected to an active Ethernet device.

The network status indicators LINK and SVC are interpreted as follows:

**SVC** – Multi-color (yellow/green). Indicates:

- a) Power
- b) RSSI

Display	Definition
Off	No Power
Yellow Blinking	Power On – No Signal (RSSI)
Yellow Solid	Power On – RSSI < -88
Green Solid	Power On – RSSI >= -88

**Part Number 91-601-01**  
**Release 1.00**

**Link** - Multi-color (red/green). Indicates:

- a) Status of IP connection
- b) Type of transport (EV-DO or 1xRTT)

Display	Definition
Off	No Connection (IP address)
Green	Connection established on 1xRTT
Red	Connection established on EV-DO

**Note – Early production units (serial number less than 0603051-010) have a different LED display.**

No service:

Green off.

Yellow on.

In service, signal less than -88, no connection:

Green LED off but does one short blink on every 4.5 seconds.

Yellow on.

In service EvDO or EVDO & 1xRTT , signal less than -88, no connection:

Green LED off but does one short blink on every 4.5 seconds.

Yellow LED off but does one short blink on every 4.5 seconds.

In service, signal greater than or equal to -88, no connection:

Green LED off but does two short blinks on every 4.5 seconds.

Yellow on.

In service EvDO or EVDO & 1xRTT, signal greater than or equal to -88, no connection:

Green LED off but does two short blinks on every 4.5 seconds.

Yellow LED off but does two short blinks on every 4.5 seconds.

In service, signal less than -88, active data connection:

Green LED on but does one short blink off every 4.5 seconds.

Yellow on.

In service EvDO or EVDO & 1xRTT, signal less than -88, active data connection:

Green LED on but does one short blink off every 4.5 seconds.

Yellow LED on but does one short blink off every 4.5 seconds.

In service, signal greater than or equal to -88, active data connection:

Green LED on but does two short blinks off every 4.5 seconds.

Yellow on.

In service EvDO or EVDO & 1xRTT, signal greater than or equal to -88, active data connection:

Green LED on but does two short blinks off every 4.5 seconds.

Yellow LED on but does two short blinks off every 4.5 seconds.

## 2.3 Connectors

### Ethernet Connectors

Connectors are found on the back of the Series 4200E SkyRouter. Ethernet ports 1 – 4 are auto polarity sensing and can be used with either a standard Ethernet cable or a reverse (cross over) Ethernet cable.

### Terminal Block

Connector J1 supports four separate functions, power, relay contact closure detection, relay driver output, and application port serial data. Contact closure pins 2 and 4 are shared with the application serial port. To option remove the circuit board and locate 3-pin headers JP1 & JP2 behind the green connector. To use the discrete I/O (Din, Dout) JP1 and JP2 should have jumpers center to right. To use the application serial port JP1 & JP2 should have jumpers center to left. Application serial port parameters (baud, parity, etc.) are set by the application program using the port.

The pin out configuration is as follows:

- Pin 1 – Din – Discrete Input (See Appendix A)
- Pin 2 – Din Src – Discrete Input Source (See Appendix A) or RxD of application port.
- Pin 3 – Dout Gnd – Discrete Output Ground (See Appendix A)
- Pin 4 – Dout - Discrete Output (See Appendix A) or TxD of application port.
- Pin 5 - Ground
- Pin 6 - +12VDC



Figure 2

## 3 Start Up

**Warning** – You must connect antennas to the SMA style antenna connectors on the SkyRouter before turning it on. Failure to do this could result in erratic start up behavior and could possibly damage the unit.

**Note** – The 4200 SkyRouter ships from the factory with its DHCP server enabled. The Default Gateway address for the unit is 192.168.1.10. The address of the web based administration is also 192.168.1.10. After you have activated your unit on the wireless network it WILL NOT have a DNS address, meaning that public Internet web access will not work. To load DNS values go to the Ethernet Interface screen, select “Acquire From Wireless Network” and press the update button. At this point the Primary and Secondary DNS addresses in the Ethernet Interface screen will be populated with the DNS addresses provided by your wireless network. As a last step restart both the SkyRouter and the connected PC.

### 3.1 Power

Before starting connect the supplied 12VDC power adapter to the power connector described in Section 3. The adapter supplied with your SkyRouter is suitable for use with 120VAC 60-hertz wall power. If you need a different power solution contact Ctek.

### 3.2 Connecting The Antenna

The antennas supplied with each SkyRouter should be attached to the SMA style antenna connectors described in section 3. The antenna must be connected before powering the unit on.

### 3.3 Connecting to the Ethernet Port – Administrative Connection

For a direct Ethernet connection between a PC connect to any of the Ethernet ports using a standard or reverse Ethernet cable. For initial configuration and administration with a PC or workstation Ctek recommends that the PC be set to obtain an IP address and obtain a DNS address automatically. For Windows PCs make the following settings under the networking control panel

#### LAN (Ethernet) Connections - Windows

Part Number 91-601-01  
Release 1.00

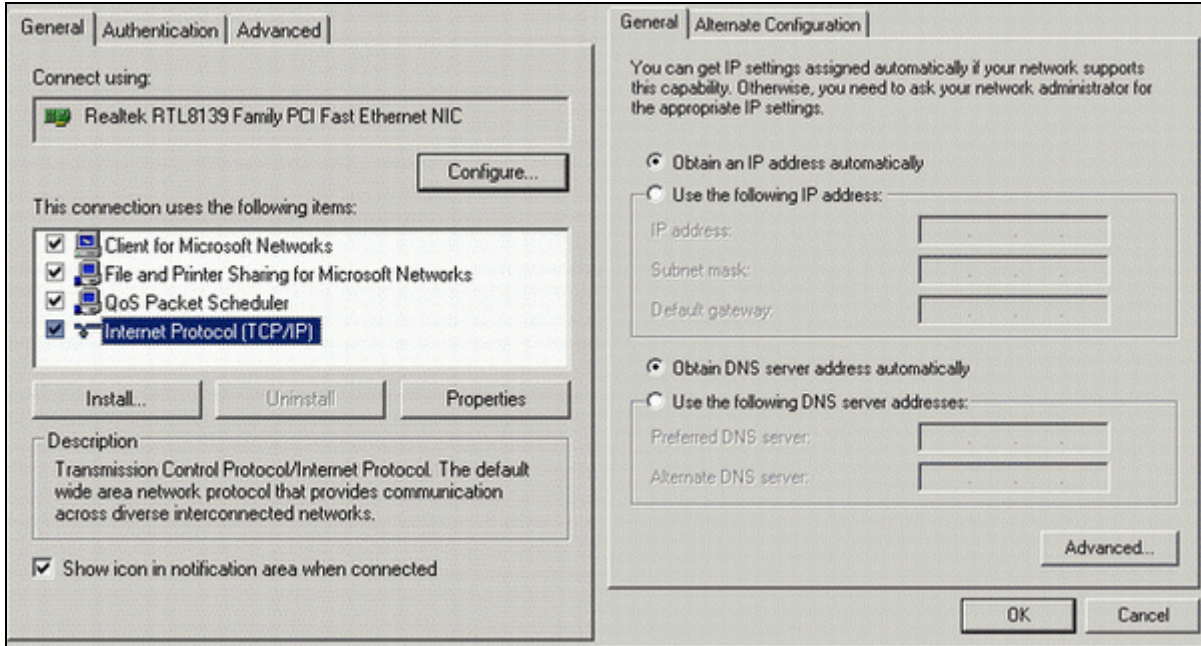

Figure 3

## 4 Administration, Configuration and Status

**About Addressing** – Devices connecting to CDMA/1XRTT networks are assigned an IP address by the serving network. Address assignment may either be static or the unit will be dynamically assigned an IP addresses, depending on arrangements that you have made with your wireless network operator. Dynamically assigned IP address remain in effect for a period of time assigned by the network operator, usually at most a small number of hours.

Ctek's SkyRouter includes features that manage the temporal nature of dynamically assigned wireless IP addresses. Using the Wireless Configuration screen you can configure your SkyRouter to use a Dynamic DNS (DDNS) service. Ctek operates a DDNS test bed that allows our customers to observe the performance and reliability of DDNS with their applications. For large-scale commercial applications Ctek recommends that users configure their own DDNS, managed and maintained with the customers ongoing IT operations. The SkyRouter may also be configured to operate with a standard DNS having Dynamic DNS capabilities. Examples of this type of service would be Berkeley Internet Name Daemon (BIND) and Microsoft Server 2000 and up. For detailed information see Ctek's TechNote S4200-01.

Even if you elect to use a static IP address a DDNS service will add value in two ways. First, when the networks static addressing assignment fails there is a mandatory waiting period before the endpoint is allowed to reinitiate the request for a static address registration. During this period of time the network will dynamically assign addresses to the end point. A DDNS service will make the end point network addressable (by name) during this period of time. Secondly, a name service allows your end point to be known by a name that is independent of network addressing. Addressing a unit by name may be easier for end users to remember and will, over a long period of time, reduce maintenance problems.

### 4.1 Getting Started

Once the PC has been set up properly and physically connected to the SkyRouter you are ready to begin configuring the Series 4200 SkyRouter for your application. To access the Administration menu use a conventional web browser pointed at [http:// 192.168.1.10](http://192.168.1.10). A login screen appears as shown below. The default User ID is "ctek" (without the quotes) and the default Password is also "ctek". Be sure to change the user ID and password and record your new selections.

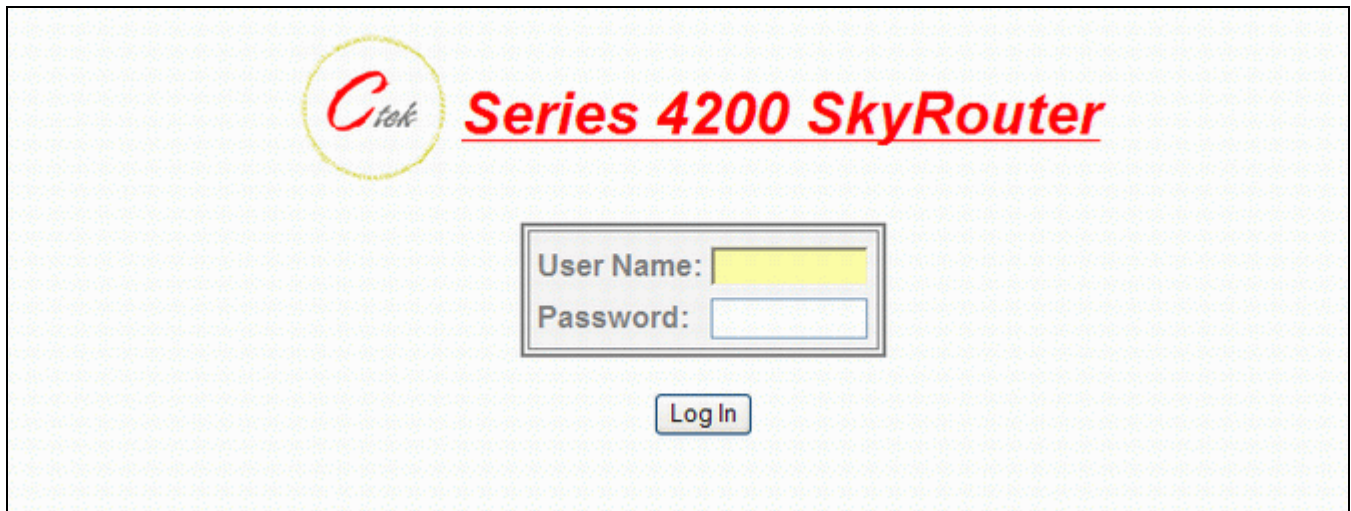

Figure 4

When you have completed the login process you will be presented with the top-level administration menu.



Figure 5

Note that the administration menu is divided into three sections. The Interfaces section deals with physical connectivity, managing the connection and subtended devices. Services are applications that are within the router core to modify the behavior of a specific interface or to change system wide parameters within the router core. Status screens are provided for the CDMA ED-DO/1XRTT and Ethernet interfaces.

**Important Note** – The Restart button **must** be used to apply any changes made on specific Interface or Service screens.

## 4.2 Interfaces

### 4.2.1 Configuring The Wireless Interface

The configuration screen for the wireless interface is shown below. The actual wireless interface is provisioned and configured by the wireless Network Operator. SkyRouter's Wireless Interface Configuration screen is used to establish inactivity timeouts and Name Server selections.

**Ctek** *Wireless Interface Configuration*

Network Select: 0 - Auto

User Name:  Wireless Connection: Enabled

Password:  Enable LCP echo packets:

Use network provided dynamic IP address  Use the following static IP address:

*Client For Dynamic IP Address Resolution*

Select DDNS Type:  None  EW/SMS  EW/UDP  Standard UDP

Device Name:

Primary Name Server:  Secondary Name Server:

Figure 6

**Network Select** – (Note: This setting should only be changed after consulting with Ctek Support.) This pull down menu allows the user to control the home network setting of the CDMA connection, effectively limiting the scope of the Preferred Roaming List (PRL) assigned by your wireless network operator. The possible settings are shown below:

**Ctek** *Wireless Interface Configuration*

Network Select: 0 - Auto

- 0 - Auto
- 1 - Home only
- 2 - 1xRTT only
- 3 - 1xRTT home only
- 4 - 1xRTT PCS only
- 5 - 1xRTT PCS home only
- 6 - 1xRTT cellular only
- 7 - 1xRTT cellular home only
- 8 - EvDO only
- 9 - EvDO home only

*Client For Dynamic IP Address Resolution*

**User Name and Password** – Required for activation on some networks. See TechNotes for specific usage.

**Wireless Connection** – Used to enable/disable the wireless WAN connection.

**Part Number 91-601-01**  
**Release 1.00**

Disabled – Turn off WAN connection  
Enabled – Turn off WAN connection

**Use Network's Dynamic IP Address** – For most networks this will be the correct selection.

**Use The Following Static IP Address** – If your selected network is capable of provisioning a static IP address to your application check this box and enter the assigned IP address. See TechNotes for network specific set up.

**Enable LCP echo packets** – Used on some International networks. For all US networks LCP echo packets should be turned off, meaning this box should be unchecked. If you have questions check with Ctek support.

**Select DNS Type** – Used to select the appropriate protocol for your Dynamic DNS.

- 1) **None** – DDNS will not be used.
- 2) **EW/SMS** – Use Ctek Enhanced Wireless DDNS with SMS updates.
- 3) **EW/UDP** - Use Ctek Enhanced Wireless DDNS with UDP updates over the EV-DO/1XRTT Air Interface
- 4) **Standard UDP** – Use a standard BIND, MS2000, or MS2003 DDNS server

**Device Name** – Establishes the name by which this particular SkyRouter will be known at the Name Server. This entry must be a fully qualified device name and domain and is limited to 40 characters in total. It is limited to one level of name space definition meaning that all characters to the right of the first “dot” will be assumed to be a component of the resolving server. An example would be *ctek01.thingme.net* where *ctek01* is the name of an individual SkyRouter and *thingme.net* is the name of the resolving server.

**Primary and Secondary Name Server** – Enter the IP address of the designated Name Server. Name resolution is not performed on this entry meaning that a numeric IP address of the resolving server is required.

**Provide Network Name Server Facilities** – Selecting Yes causes this SkyRouter to provide Name Server services to client SkyRouters configured to use it. If this option is selected additional set up in the Name Services screen will be required.

## 4.2.2 Configuring The Ethernet Interface

The Ethernet configuration determines how devices connected to the LAN side of SkyRouter will be addressed, and what the actual address of this SkyRouter will be on the LAN.

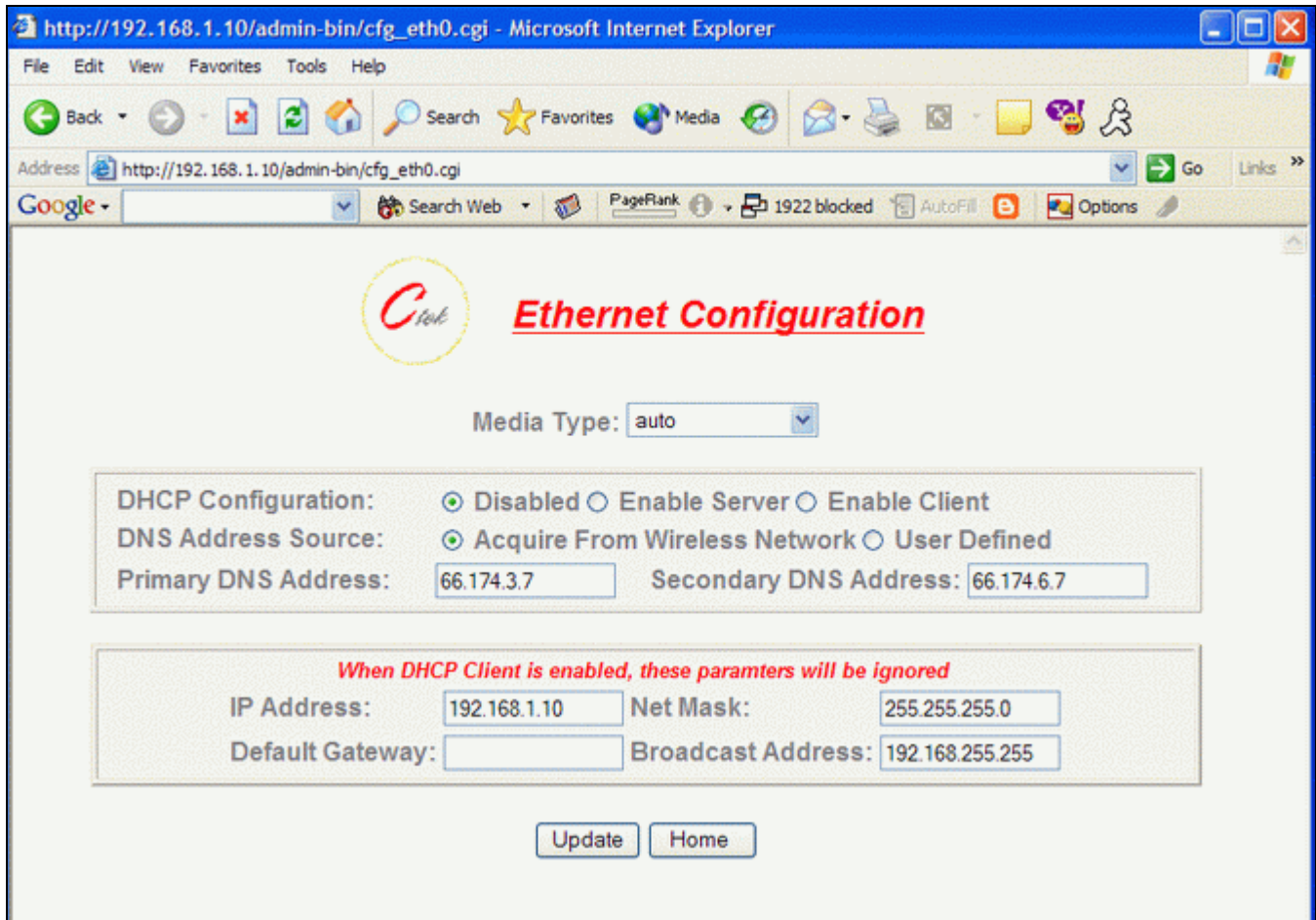

Figure 7

**Media Type** – Determines the type of Ethernet connection. Auto allows SkyRouter to determine what the connection is. This setting is appropriate for most cases. Other settings are to select either 10Mb (10baseT), 100Mb (100baseT), Full Duplex (FD), or Half Duplex (HD). Again, in almost all cases Auto will correctly determine the proper setting.

**DHCP Configuration** – These settings determine the network topology of the LAN side of SkyRouter's network.

**Disabled** – You must manually configure the IP address and other addressing parameters described in the next section . It is recommended that the SkyRouter be assigned a private static address of 192.168.1.10.

**Enable Server** - This SkyRouter must be assigned a private static IP address, as defined in the next section. It is recommended that an address of 192.168.1.10 be used. The DHCP server will issue dynamic IP addresses to other devices connected to the LAN side. IP addresses will be assigned for up to 50 devices. Address assignment is sequential in the range of 192.168.1.100 – 192.168.1.150.

**Part Number 91-601-01**  
**Release 1.00**

Enable Client – Some other device on the LAN side of the network is acting as a DHCP server. SkyRouter will be assigned a dynamic IP address by the DHCP server.

DNS Address Source – In most cases this parameter should be set to Acquire From Wireless Network. In this case, when you click on the Update button, the Skyrouter will verify that it has been connected to the wireless network and that the wireless network has provided DNS addresses. If DNS addresses have been provided, they will be displayed in the Primary and Secondary Address boxes. If addresses have not been provided, you will receive an error indication. At that point, you should allow the SkyRouter to establish a connection with the wireless network so that it can acquire the DNS addresses. You should then go back into the Ethernet Configuration screen and click on submit again. At this point, the DNS addresses should appear.

If your application requires a specific DNS setting check the User Defined box and manually fill in the DNS IP Address fields below.

DNS IP Address (Primary and Secondary) – The address of the Domain Name Server that your network uses. This should not be confused with the Name Server entries on the Wireless Interface screen. The DNS referenced by these addresses will resolve outbound queries.

IP Address – The IP address assigned to the LAN segment of this SkyRouter.

NetMask – This parameter is also known as Subnet Mask. Network Mask determines which portion of an IP address is the network portion and which portion belongs to the host. As an example a setting of 255.255.255.0 would indicate that the first three groups of this address (255.255.255) identify the network and that the last group (000 – 254) identify a particular host.

Default Gateway – The Default Gateway is the address of a device that SkyRouter will use to reach remote networks or servers. In many cases this will be a firewall address. In a normal situation where the 4200 is acting as a fringe router and is expected to pass incoming Ethernet traffic through to the CDMA network, this field should be left blank. If the 4200 is acting as a RAS where traffic is coming in from the CDMA network so that it can be routed through to some sort of host/server, this field must be set to an address on the 4200's LAN segment.

**Broadcast Address**

If applications on the 4200 need to do a broadcast operation, this is the address that will be used on the Ethernet segment to fulfill the broadcast request.

### 4.2.3 Configuring The Relay Input Interface

This screen configures the connection characteristics of the relay input interface and defines the service associated with this interface. Currently, the relay interface can cause an SMS message to be sent to another wireless device or an e-mail message to be sent to any valid email address.

Appendix A contains schematic information concerning the relay input configuration.

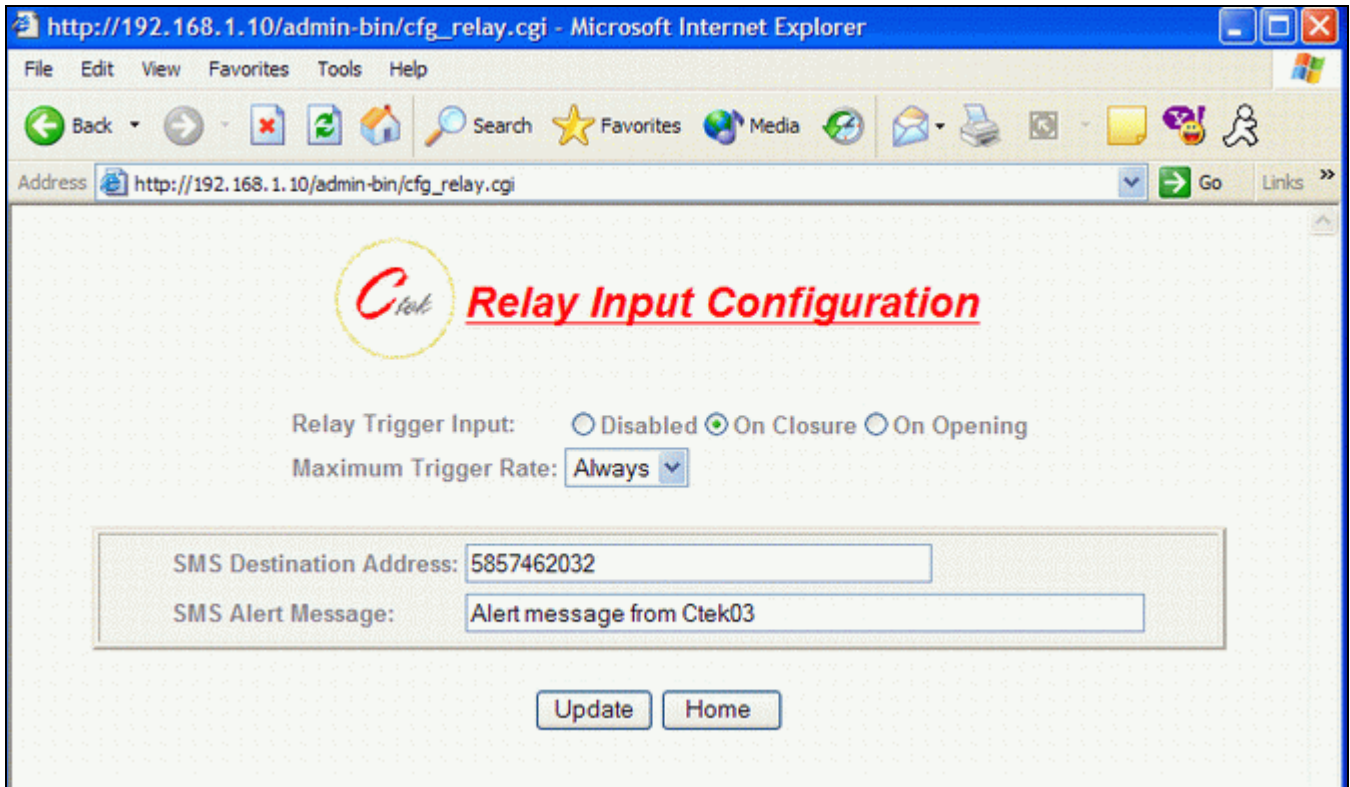

Figure 8

**Relay Input Trigger** – Establishes the conditions under which the Relay Service will be invoked. Unless it is disabled the relay input is sampled at 1000 millisecond (1 second) intervals.

Disabled – Never respond to relay activity

On Closure – Respond when relay contacts go closed

On Opening - Respond when relay contacts go open

**Maximum Trigger Rate** – This setting determines how often the SkyRouter will send a “relay event” message. If the relay event is recurring at a rapid rate this setting will prevent an undesirable “flood” of messages. If **Maximum Trigger Rate** is set to **"Always"** the relay input is operating in edge triggered mode. In this mode the SkyRouter will invoke its assigned service any time that the input transitions to the selected state. So if **ON CLOSURE** is selected an SMS is sent every time that the contacts close. This means that once closure is sensed there can be no other closure event until the contacts are first sensed to be open.

All other modes where Max Trigger Rate has a time value are level sensitive. So if the contacts close an SMS is sent and then the state of the relay input is ignored for a defined period of time. For instance, if **Max Trigger Rate** is set to **5 minutes** an SMS is sent and then the relay input is sampled again in 5 minutes. If the contacts are still closed another SMS is sent. If the relay input is not closed SkyRouter reverts to monitoring the relay every second.

**SMS Destination Address** – The MIN (mobile phone number) or email address to which the SMS message will be sent. MIN must be 10 numeric characters with no spaces or punctuation. Any email address in the form *Anything@Any\_Domain* will be accepted.

**SMS Alert Message** – The text of the message to be sent when the relay interface activates. Limited to 100 characters maximum. Only printable ASCII characters in the range of 32 – 126 decimal (20 – 7E hex) can be included in the message.

#### 4.2.4 **Configuring The Relay Output (Driver) Interface**

This screen configures the connection characteristics of the relay output interface and defines the service associated with this interface. Currently, the relay output interface can be activated by an SMS message or from a button that can be defined on the Advertising screen described in the Services section.

Appendix A contains schematic information concerning the relay output configuration.

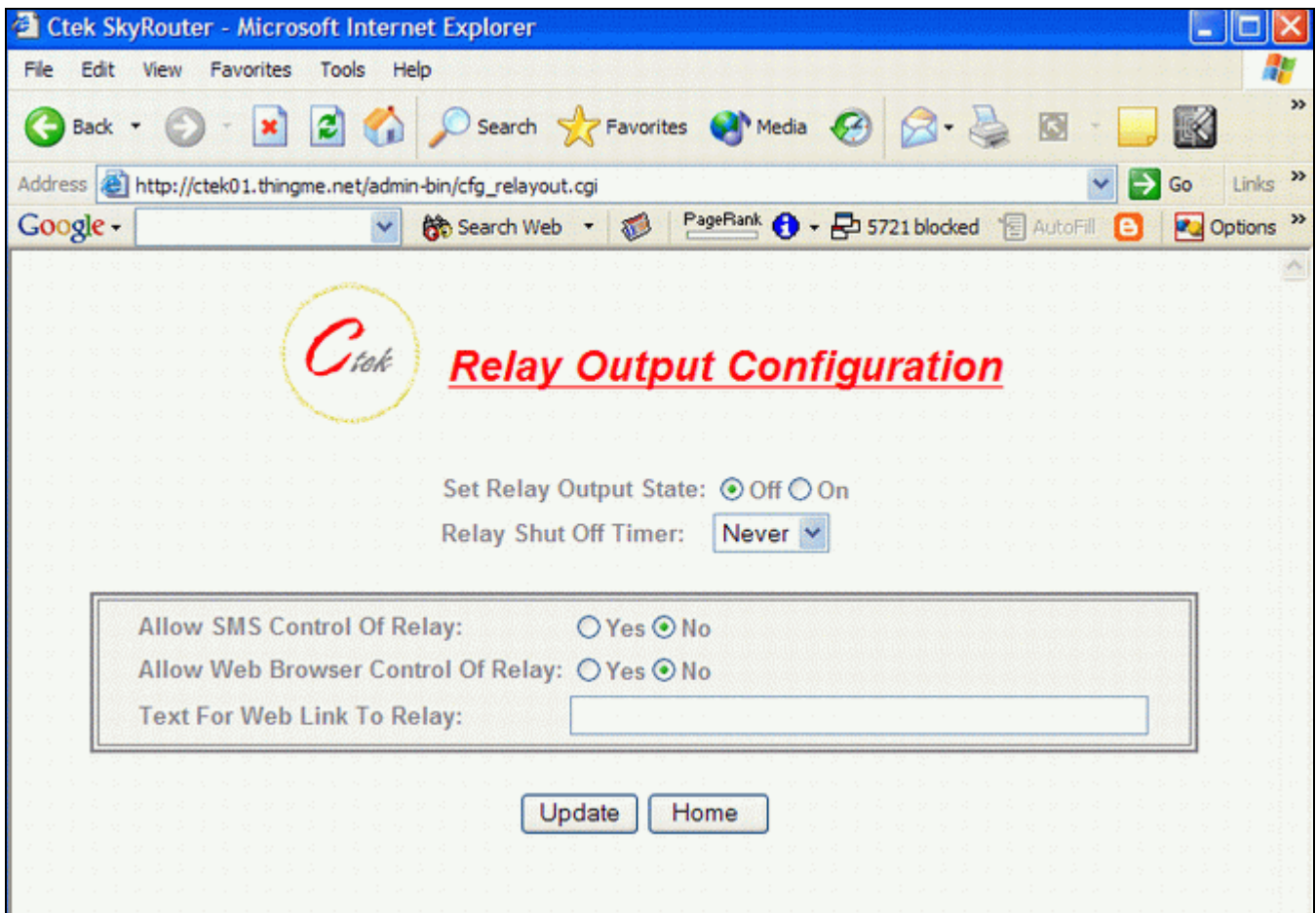

**Set Relay Output State** – Used to set the current state of the relay driver circuit. The relay driver can be activated and deactivated by changing this setting and pressing update.

**Relay Shut Off Timer** – The relay driver circuit will revert to its default setting after the number of minutes or seconds specified by this parameter. The two second setting is useful for resetting end point equipment.

**Part Number 91-601-01**  
**Release 1.00**

**Allow SMS Control of Relay** – If Yes is checked the relay driver may be activated by sending an SMS with the command “R1” and deactivated by sending an SMS with the command of “R0”.

**Allow Web Browser Control of Relay** – If set to yes a button will appear on the Advertising screen to enable and disable the relay driver circuit.

**Text For Web Link To Relay** – This text will appear on the advertising screen next to the relay activation button.

### **4.3 Services**

#### **4.3.1 Password Administration**

Used to change passwords and create users. Be sure to record this information in a secure location.

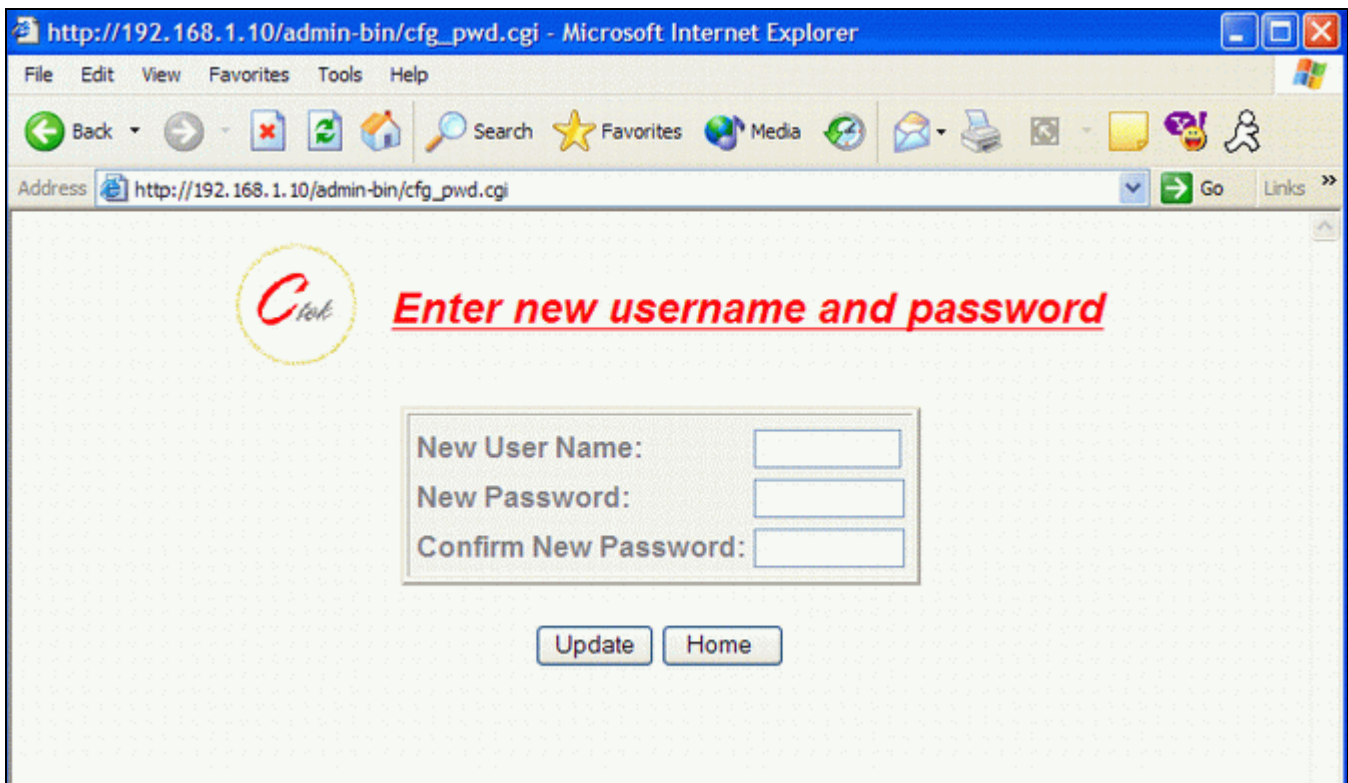

**Figure 9**

### 4.3.2 Routing and Forwarding Services

The Routing and Forwarding Services screen provides two separate but related functions. First it allows you to forward WAN side IP traffic arriving on a specific IP Port to a specific Port at a LAN side address. In addition to this conventional forwarding feature this screen also allows you to make a Named Service publicly available over the WAN interface. In Figure 10 below WAN side UDP and TCP traffic arriving on Port 88 is redirected to Port 80 of LAN address 192.168.1.102.

The second function performed by this set up screen to allow named services to be made publicly available to WAN side users. Referring again to Figure 10 a service named "Ctek SkyRouter Demo – San Pedro, CA" will be advertised or made publicly available. Security for this advertised service is left up to the specific service. If the Advertising feature is used the Administrative Login screen will no longer greet incoming WAN users, instead they will be presented with a Services screen as shown in Figure 11.

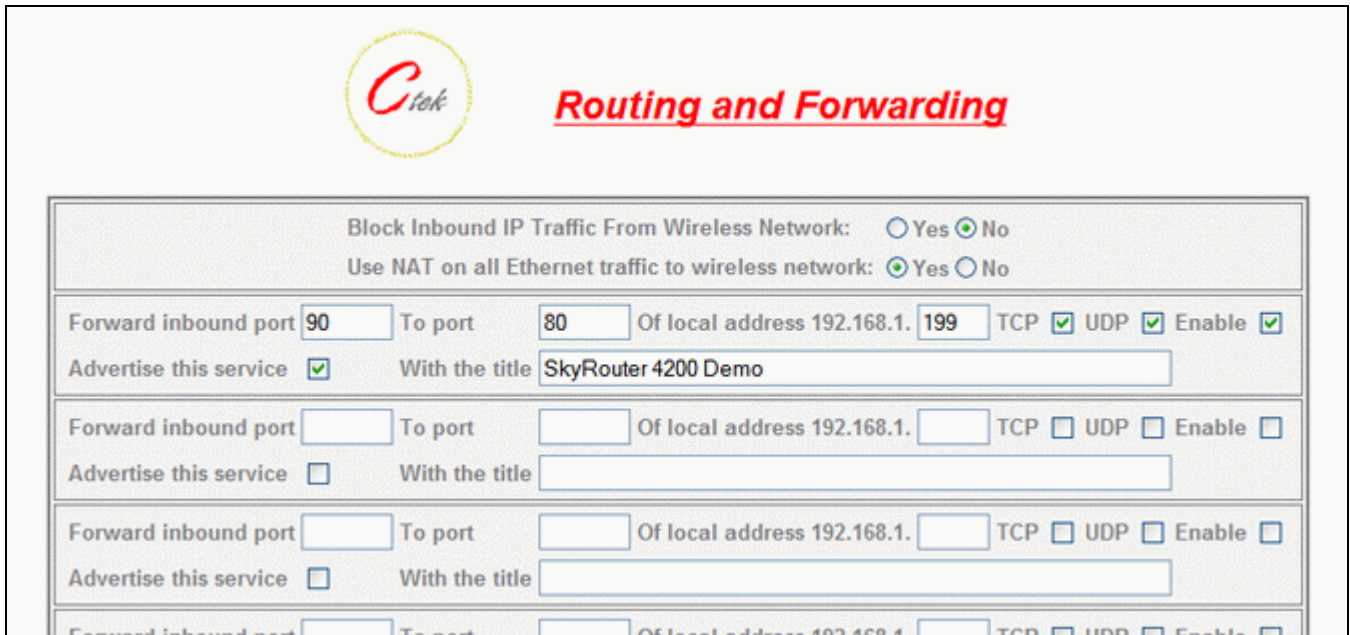

Figure 10

**Block Inbound IP Traffic From Wireless Network** – If set to Yes the SkyRouter’s firewall is configured to block any inbound originated (but not response) packets from the wireless network (WAN). This firewall is then selectively modified by the forwarding entries defined through this screen. If this parameter is set to No, the SkyRouter’s firewall is disabled.

**Use NAT on all Ethernet traffic to wireless network** – For normal operation this parameter should be set to “Yes”. In some unique situations, you may connect the SkyRouter to a network where you will be given public address to use on your LAN’s Ethernet segment. In such cases, NAT should be turned off. NAT is currently required for operation on all US networks such as Sprint, Verizon or Alltel. Typical environments where NAT would be turned off would be private networks or some types of VPNs and in these cases, the network operator will most likely provide configuration assistance.

**Forward Inbound Port** – This table allows WAN side packets addressed for specific IP ports to be routed to a specified address on the LAN side.

**Of Local Address** – Used to specify the LAN side address of the routing operation.

**TCP** – Route TCP/IP traffic

**UDP** – Route UDP/IP traffic

**Enable** – Activate this routing setting

**Advertise This Service** – Display this named service for WAN users

**With Title** – The name assigned to this service

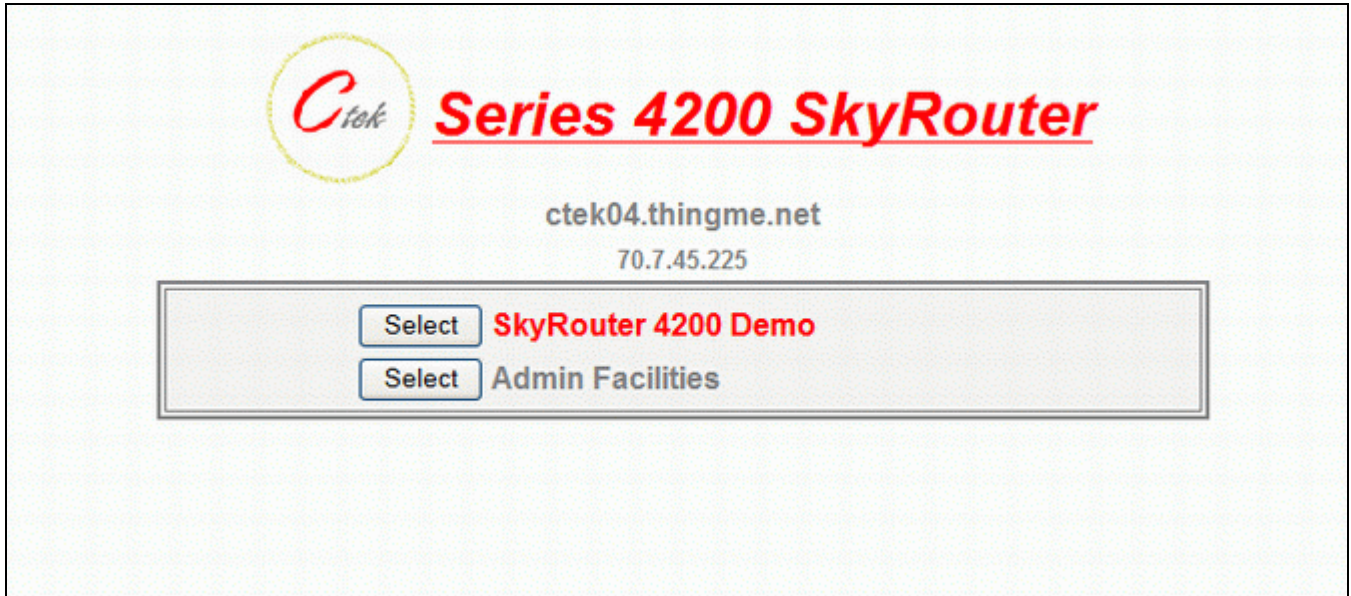

Figure 11

### 4.3.3 Admin Screen Services

This service allows the user to control overall local and remote administrative access.

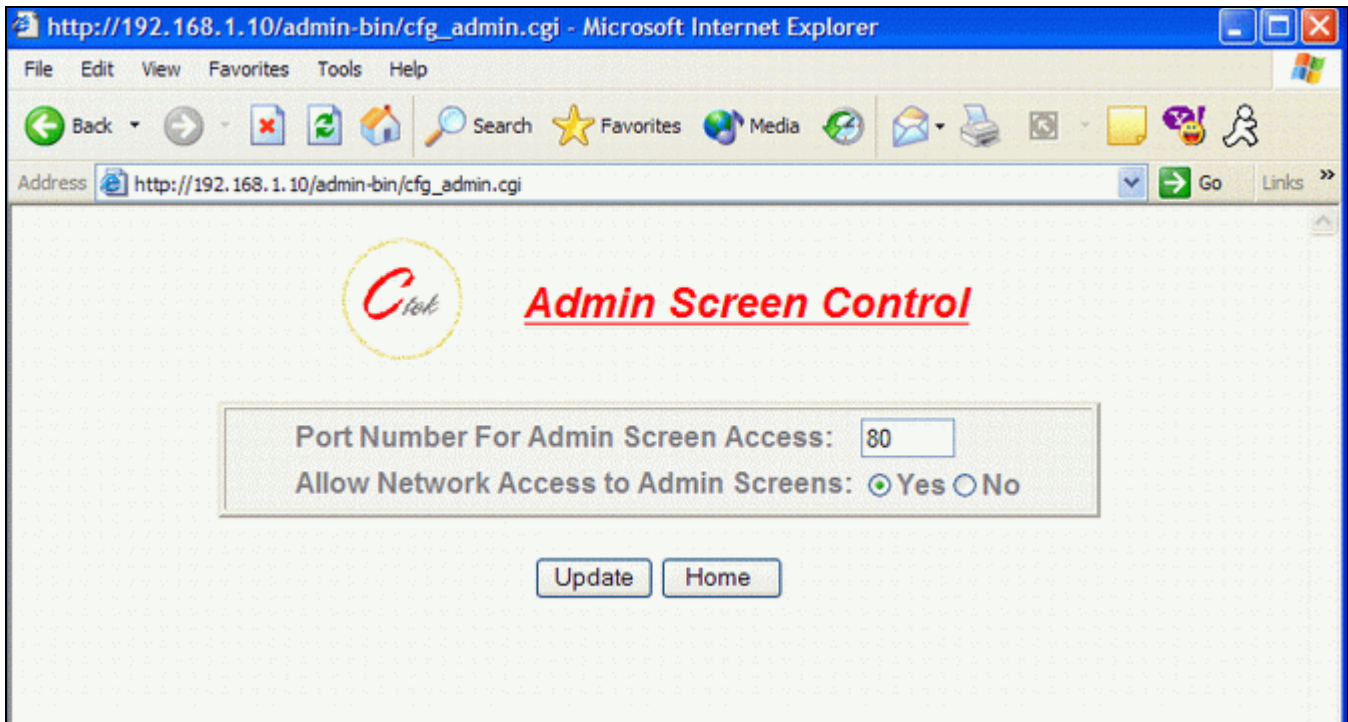

Figure 12

**Port Number For Admin Screen Access** – Causes the WAN side web server to listen on a port other than the default of Port 80.

**Allow Network Access To Admin Screens** – If set to Yes administrative users will be able to connect to SkyRouter's Admin interface over the EV-DO/1XRTT network connection. If this selection is set to No only local administration is possible.

### **4.3.4 Wireless Activation Services**

**Note** – Before using the Wireless Activation Services Interface for any purpose you must first turn off the SkyRouter's WAN interface. This is accomplished by setting the Wireless Connection pull down on the Wireless Interface screen to disabled, clicking update, and then doing a restart of the unit.

The Wireless Activation Services interface serves two purposes. First, it provides a mechanism to activate the SkyRouter on the wireless networks utilizing a form of Over The Air (OTA) activation. Secondly it may be used as a general interface to enter specific commands, known as AT commands, to the SkyRouter's radio module.

**Over The Air Network Activation** – If the wireless module in your SkyRouter is capable of performing an OTA activation you will be presented with the option to select the appropriate activation method. Currently this capability is limited to the OMA-DM method for Sprint-Nextel or the OTAS method for Verizon Wireless. The Verizon Wireless OTAS also updates the unit's PRL and can be redone whenever a new PRL is required. Sprint OMA-DM is capable of downloading a PRL over the air but the feature is not yet implemented in the network. Because of the differences in PRL strategies the Verizon Activation Services screen is different than the Sprint version.



Figure 13 (Sprint)

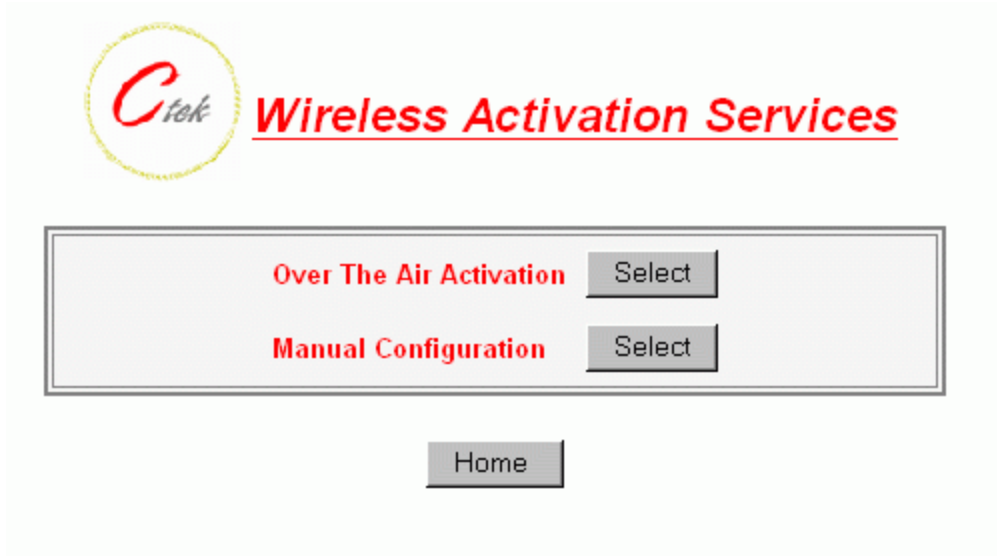

Figure 14 (Verizon Wireless)

Selecting the Over The Air Activation option on either of these screens will cause the actual activation screen (Figure 24) to be displayed.



Figure 15

**Activation Status** – Activated or Not Activated

**Network Stability** – Indicates OK For Activation if during the previous two minute sample period the RSSI is less than (smaller negative number) -99dBm, the SID has not changed, and the unit has access to 1xRTT connectivity. IOTA activations do not currently occur when the connection is EV-DO only.

**Activate** – Causes the unit to contact the network for an over-the-air activation

**Status** – Refreshes the current screen so that progress can be monitored.

**Details** – Displays a scrolling screen (Figure 25) with low level messages between the unit and the network. Useful when an activation problem is encountered.

**Back** – Return to the Activation Services screen.

Detailed information on IOTA or OTAS activations are covered in the TechNote appropriate for your network. The Status and Details buttons can be used to monitor the activations progress.

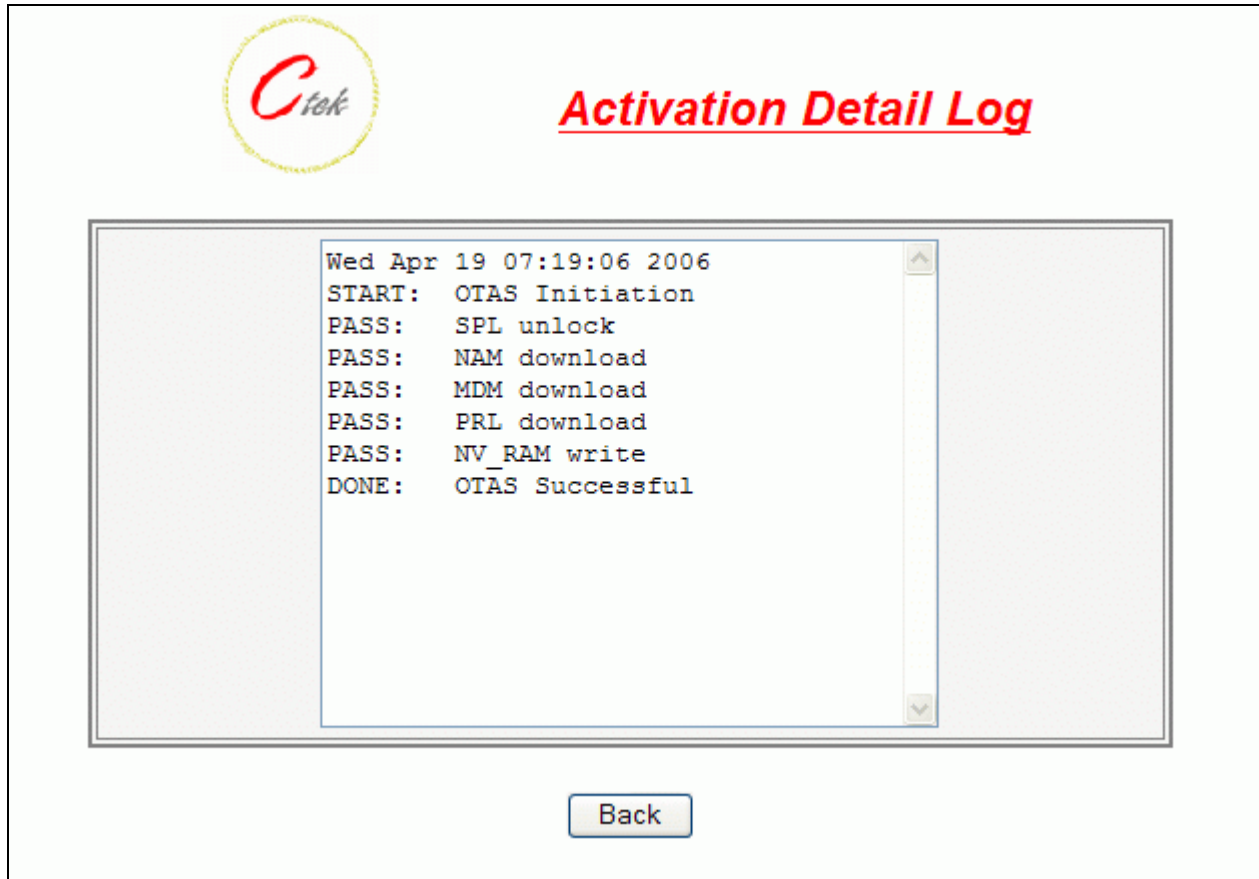

Figure 16

**Manual Configuration** – Manual activations are performed using specific AT commands to program the SkyRouter's radio module. The Manual Session selection is a general purpose AT command interface that can be used to perform manual activations or to enter and observe other AT commands as required. AT commands (Example ATDT) are entered in the top field on the Manual Activation screen and the resulting radio and/or network status is displayed in the scrolling region below.

**Ctek** Manual Activation Process

Command:

Figure 17

**PRL Updates – (Sprint)**

For information on manually updating a PRL on a Sprint SkyRouter see TechNote TN0015.

To update a PRL on the Verizon Wireless network the activation process should be redone.

\*\*\* **NOTE** \*\*\* Over the air PRL updates on the Sprint network are not currently implemented.



## PRL Update Process

Current PRL: <b>60711</b>	Update Status:
MASTER SPC(Unlock): <input type="text"/>	
PRL NUMBER: <input type="text"/>	<input type="button" value="v"/>

Figure 18 (Sprint)

### 4.3.5 Applications

The SkyRouter is capable of installing and managing custom applications. The Applications Services screen is the user interface to manage custom applications. The individual application release documentation will document the individual applications behavior.

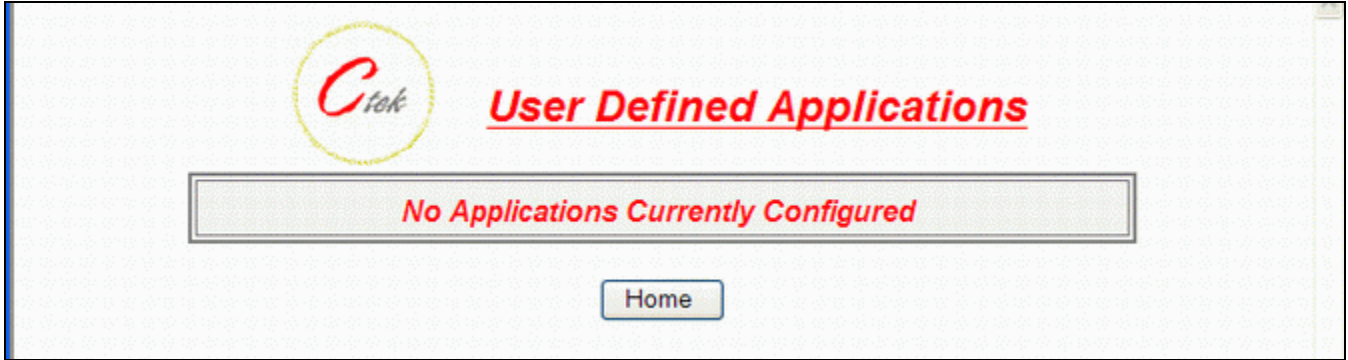

Figure 19

## 4.4 Status

### 4.4.1 Wireless Status

The Wireless Status interface provides information on the SkyRouter's wireless network connection, local operating conditions, and predefined information contained within the radio module. Wireless status information is presented in two levels of detail, summary and detailed. Either level can be refreshed (updated) in real time using the Refresh button at the bottom of the page. The Wireless Status interface is display only.

#### Wireless Status Summary Screen



Figure 20

### **Wireless Status Field Definitions – Summary Display**

**ESN** – An identifier assigned to the CDMA radio for this SkyRouter. The value is given in decimal (Dec) and Hexidecimal (Hex).

**System ID (SID)** – Numeric Identifiers assigned to local market areas within a wireless network. Your wireless network operator may request this information if you are having trouble connecting to the network.

**Phone Number (MDN)** – The circuit side phone number of the CDMA radio in your SkyRouter. MDN stands for Mobile Directory Number.

**Network Status** – Either In Service or Out of Service. Indicates the state of the network as seen through your particular SkyRouter.

**Signal Level (RSSI)** – A measure of the strength of the wireless signal that your SkyRouter is currently seeing. A larger negative number indicates a marginal network connection. Typically this number will be in the range of -75 - -95dBm although there are many locations where the value will be outside of the typical range.

**Service Type** – The type of bearer channel this SkyRouter is operating on. Options are None, 1xRTT, 1xRTT and EVDO, or EVDO.

**Current IP Address** – The Internet Protocol (IP) address assigned to this SkyRouter by the serving wireless network. If this field is blank a connection does not currently exist.

**Band** – The range of spectrum that this unit is operating on. Options are PCS or Cellular

**Call Status** – Indicates the current status of network registration

Idle - - Not registered (disconnected), a unit that is idle will not have a valid IP address.

Connected – Registered and active on the network. A connected unit will have a valid IP address.

Dormant – Registered but inactive. Wireless data connections transition to the dormant status after a brief period of inactivity. The dormant state is a normal condition.

**Roam Status** – Indicates the network's view of the current geographic location of your SkyRouter. The possibilities are Not Roaming (Home), Roaming, or Blink Roaming. An indication of Roaming may or may not impact your data transmission costs. Charges are a function of your rate plan, not necessarily linked to the networks notion of roaming.

**Temp Alert** – Indicates the status of the radio's internal temperature sensing. Options are Temp OK, Over Temp Disconnect, or Over Temp Shut Down. Temp OK indicates that the sensed temperature is less than 85 degrees Centigrade. A Temp Disconnect indicates that the radio is attempting cool down procedures and a Over Temp Shut Down indicates that cool down procedures have failed and the radio has shut down to protect itself.

Wireless Status Details Screen

The image shows a screenshot of the 'Wireless Interface Details' screen. At the top left is the Ctek logo. The title 'Wireless Interface Details' is in red. Below are four panels: 'Radio Configuration' with fields for Radio Type (Sprint), PRL Version (20212), Firmware Rev (p1708100), Hardware Rev (3), ESN - Dec (09602660994), ESN - Hex (60289A82), MSID (8056366504), and MDN (8056366504); 'Current Status' with fields for System ID (4145), Signal Level (RSSI) (-97dBm), Network Status (In Service), Roam Status (Not Roaming), Service Type (1xRTT and EvDO), Current IP Address (68.27.90.36), Band (PCS), Call Status (Dormant), Current Temp (33 C), Temp Alert (Temp OK), and Activation Status (Not Activated); '1xRTT Status' with ECIO (-15), RSSI (-84dBm), and Channel (50); and 'EvDO Status' with ECIO (-26), RSSI (-97dBm), and Channel (50). At the bottom are 'Back' and 'Refresh' buttons.

Radio Configuration			
Radio Type:	Sprint	PRL Version:	20212
Firmware Rev:	p1708100	Hardware Rev:	3
ESN - Dec:	09602660994	ESN - Hex:	60289A82
MSID:	8056366504	MDN:	8056366504

Current Status			
System ID:	4145	Signal Level (RSSI):	-97dBm
Network Status:	In Service	Roam Status:	Not Roaming
Service Type:	1xRTT and EvDO	Current IP Address:	68.27.90.36
Band:	PCS	Call Status:	Dormant
Current Temp:	33 C	Temp Alert:	Temp OK
Activation Status:	Not Activated	Network Stability:	OK For Activation

1xRTT Status		
ECIO:	-15	RSSI: -84dBm
		Channel: 50

EvDO Status		
ECIO:	-26	RSSI: -97dBm
		Channel: 50

Figure 21

Wireless Status Field Definitions – Detailed Display

The Wireless Status Details screen is subdivided into four panels, Radio Configuration, Current Status, EV-DO Status and 1xRTT status. All values found on the Summary screen are repeated on the Details screen.

**Radio Configuration Panel**

**Part Number 91-601-01**  
**Release 1.00**

**Radio Type** – Indicates the type of programming originally loaded into the radio module. Distinct radio types do not exist for all networks meaning that a unit operating on a given network may have been repurposed from one of the existing radio types.

**PRL Version** – The Preferred Roaming List (PRL) currently loaded in the radio module.

**Firmware Rev** – The revision level of the firmware currently loaded in the radio module.

**Hardware Rev** – The revision level of the radio module.

**MSID** – Mobile Station Identification (MSID) a second phone number assigned to the module

**Current Status Panel**

**Current Temp** – The temperature currently being sensed by the radio module. Values are in Centigrade.

**Activation Status** – Indicates whether or not the SkyRouter has been successfully activated on the serving network.

**Network Stability** – Indicates whether or not the current network connection is of adequate quality to perform an OTA activation.

**1xRTT Status Panel**

**ECIO** – A figure of merit (Ec/Io) describing how well the SkyRouter can hear (forward link) the serving network when all other traffic and noise on the same channel is considered. Lower numbers indicate a better quality connection. A strong (small) RSSI does not necessarily equate to a low Ec/Io value.

**Channel** – The specific CDMA channel that the SkyRouter is currently using to communicate with the serving network.

**EVDO Status Panel** – Same as the 1xRTT Status Panel only for the EV-DO bearer.

**4.4.2 Ethernet Status**

Indicates the current LAN side IP address that the SkyRouter is using. MAC Address is a vendor and machine specific identification code.

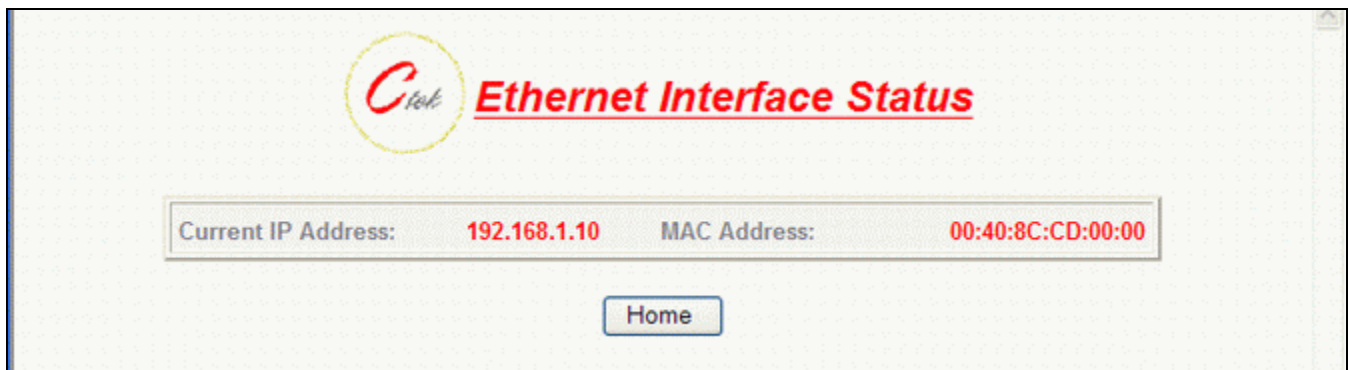

**Figure 22**

## 5 Specifications

### Controller

Axis Etrax 100LX MCM 4+16  
Linux 2.4

### Interfaces

**Four Port Ethernet Switch** - RJ45 Ethernet 10/100baseT Full or Half Duplex auto polarity sensing

**Relay Input Interface** - Designed to detect closure or opening of relay contacts.

Physical – 2 Pin Terminal Block  
See Appendix A for details

**Relay Output Interface**

Physical – 2 Pin Terminal Block  
See Appendix A for details

**Wireless Interface**

CDMA EV-DO with 1XRTT fall back  
Physical – SMA Antenna (removable)  
CDMA Approvals – Compliant with: IS-95, CDMA 2000 specifications. FCC: Part 22, 24 and 15.

### Power Requirements

Standard – 9 - 18VDC  
*115VAC -> 12VDC Wall Transformer included.*

### Power Consumption @12VDC nominal

CDMA Radio Off - 180ma  
CDMA Radio On – Data Channel Inactive – 230ma  
CDMA Radio On - 1 Ethernet Port Connected – 384ma  
CDMA Radio On – 4 Ethernet Ports Connected – 445ma

### Environmental

Operating temperature range: - 20C to +70C. Humidity: 90% non-condensing.

### Physical

Dimensions: 5.275"L x 5.225"W x 2.08"H. Weight: 12oz.  
Mounting – Self standing or wall mount

## 6 Certifications

### FCC Part 15

This equipment has been tested and complies with the limits for a Class A computing device according to U.S. Code of Federal Regulations, Title 47, FCC Rules and Regulations Part 15. Operation is subject to the following two conditions:

- 1) This device may cause harmful interference, and
- 2) This device must accept any interference received, including interference that may cause undesired operation.

**Testing for compliance with Measurement Requirements (CFR 47 Part 22, Paragraph 22.917(b)(2) and Part 24, Paragraph 24.238(a))**

**WARNING:** To reduce any possible hazard due to exposure of the human body to electromagnetic radiation, per FCC OET Bulletin 65, this device is approved for operation using the antenna provided. The antenna installation must provide a separation distance of 20 cm or more between the antenna and all persons to satisfy Maximum Permissible Exposure (MPE) compliance.

## 7 Appendix A

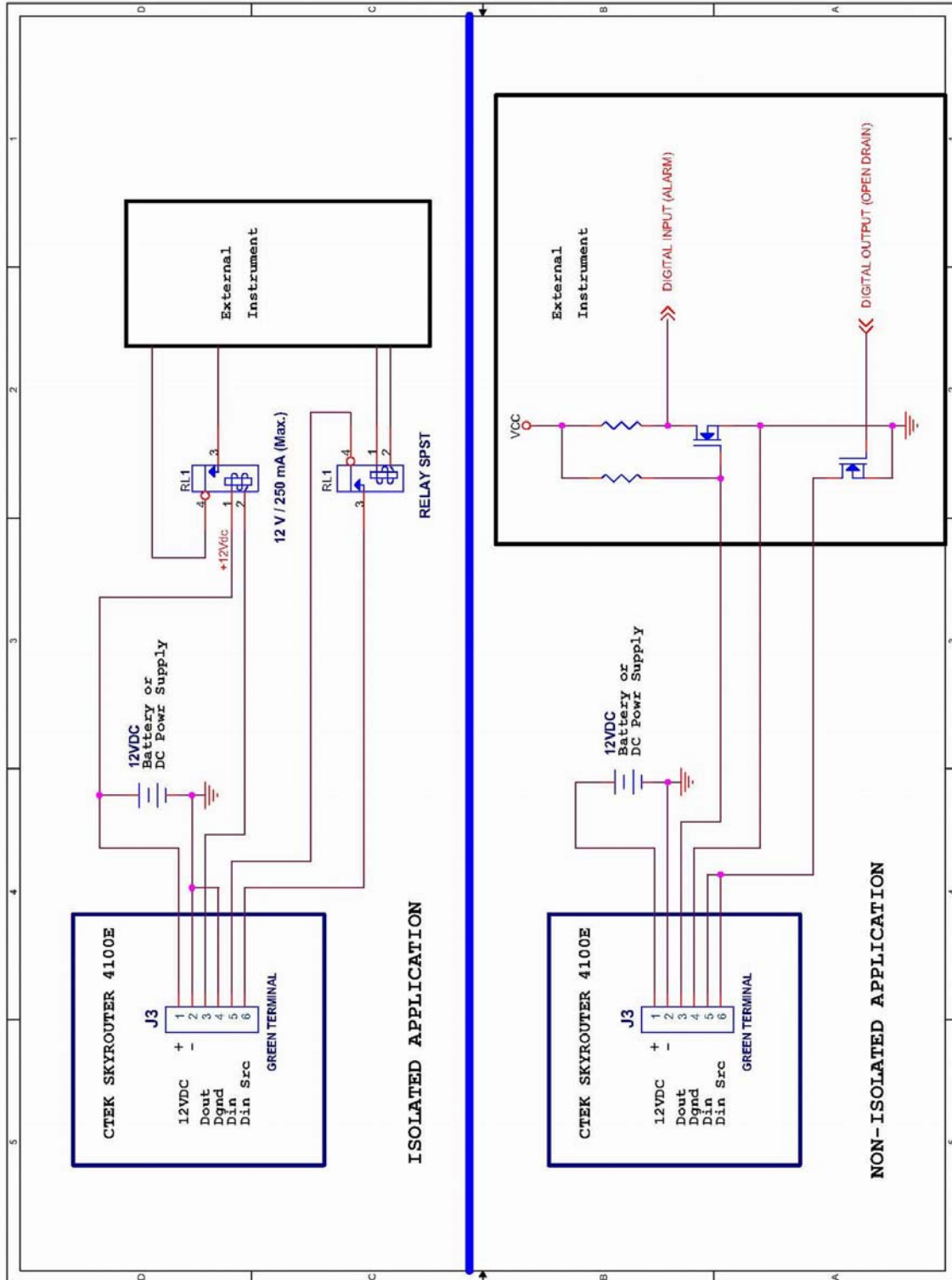

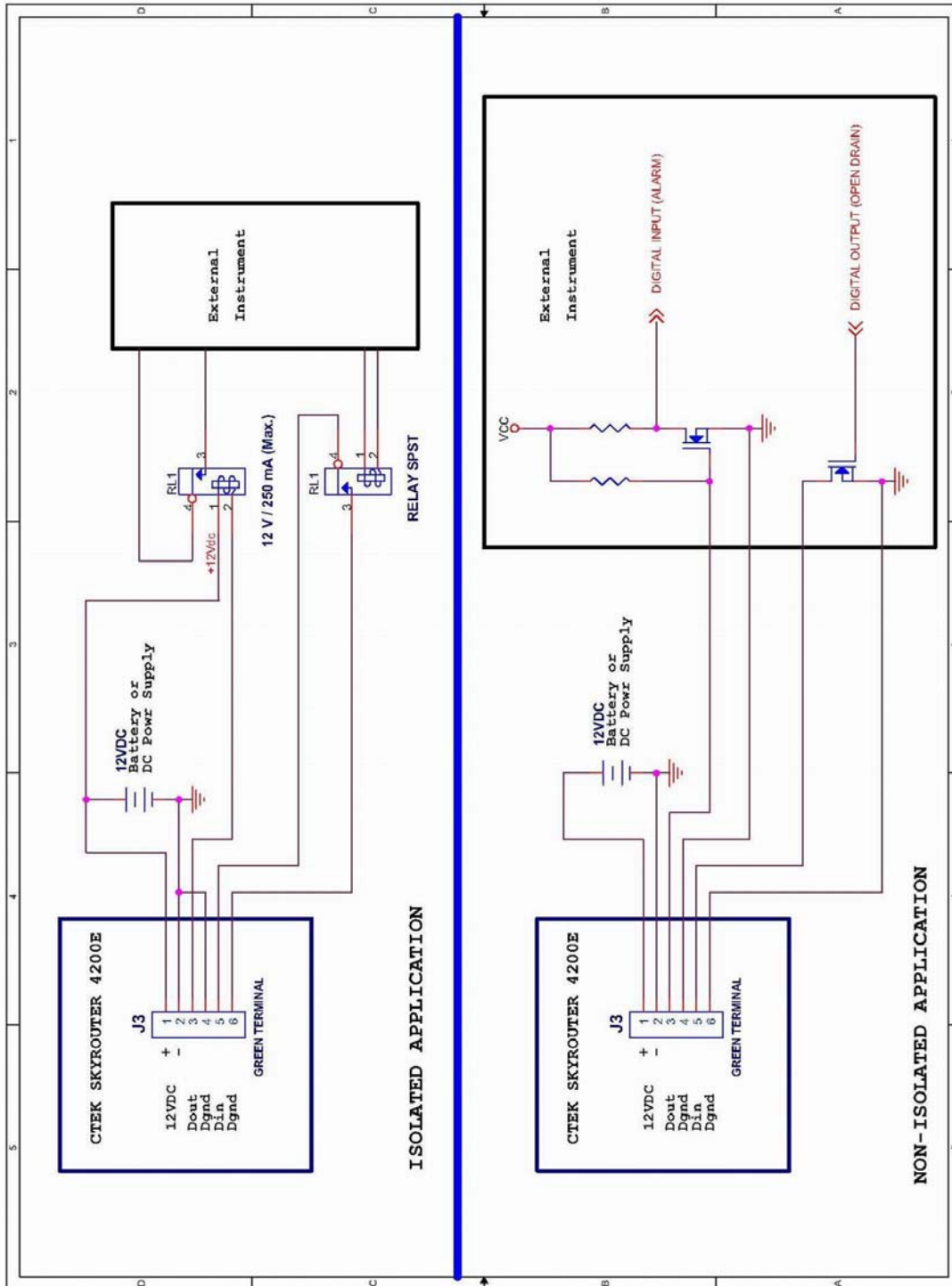

Part Number 91-601-01  
Release 1.00

